

SIZE 00

SEMICONDUCTOR PROTECTION FUSES



PROTISTOR FUSES

690V

gRB-URB FROM 16 TO 450A

SIZE: 00

Features/Benefits

- **Extremely high Interrupting rating Fuses:**
Protection of power Semiconductors according to IEC 269.1 and 4
- **690V Voltage Rating**
- **gR Class** [gRB Ratings 16 to 160 A] According to VDE 636-23
 - Full range protection
 - Improving safety and protection
 - Allows selective coordination
- **aR Class** [URC and URD Ratings 16 to 450A] According to VDE 636-23 and IEC 269.4
- **Connections According to:**
 - DIN 43653/00C 80 and 110mm Between Axes
 - DIN 43620/00C Solid Blades
- **Optional pin indicator for operating a microswitch**

APPLICATIONS DATA



VOLTAGE RATING U _N (V)	CLASS	CURRENT RATING I _n (A)	MELTING I ² t @ 1 ms I ² t _p (A ² s)	TOTAL CLEARING I ² t @ UN I ² t _t (A ² s)	WATT LOSSES		TESTED INTERRUPTING RATING	ESTIMATED INTERRUPTING RATING
					0.8 I _n	I _n		
690	gRB	16	8	61	2.7	5	200 k A @ 690 V	300 k A @ 690 V
		20	12	86	3.3	6		
		25	18	140	4.4	8		
		32	39	250	6.0	11		
		40	68	450	7.1	13		
		50	116	750	8.8	16		
		63	210	1400	9.9	18		
		80	525	3000	10.5	19		
		100	970	5400	10.7	19.5		
		125	1710	9600	13.2	24		
	160	4270	22400	13.7	25			
	URB	16	7	52	3.8	7	200 k A @ 690 V	300 k A @ 690 V
		20	10	75	5.0	9		
		25	15	120	6.0	11		
		32	32	210	8.2	15		
		40	61	400	9.9	18		
		50	102	700	11.5	21		
		63	177	1200	12.6	23		
		80	390	2200	13.8	25		
		100	692	3900	15.4	28		
125		1170	6600	18.1	33			
160	2680	14 000	19.8	36				
200	4690	24 000	23.1	42				
250	8300	42 500	27.5	50				
315	17 520	81 000	31.9	58				
350	25 450	118 000	33.0	60				
400	33 200	150 000	38.5	70				
600	URB	450**	51 850	225 000	40.7	74	200 k A @ 690 V	300 k A @ 600 V

Note: voltage rating of 350-400-450 A rated fuses is defined with a CC' curve at 1 second limited by the minimum breaking current.

• Voltage rating: 690V with CC' at 1s - 450V with CC' at 10 s
 **Voltage rating: 600V with CC' at 1s - 450V with CC' at 10 s

SIZE 00

SEMICONDUCTOR PROTECTION FUSES

**GERMAN STANDARD ACCORDING TO DIN 43653/00C
- DIN 80 & 110**

**gRB
DIN 80**

CURRENT RATING	CATALOG NO.	REF #	I/IN FUSE-BASE
16	6,9 gRB 00 D08L 016	S330273	1
20	6,9 gRB 00 D08L 020	S330227	1
25	6,9 gRB 00 D08L 025	T330228	1
32	6,9 gRB 00 D08L 032	V330229	1
40	6,9 gRB 00 D08L 040	W330230	1
50	6,9 gRB 00 D08L 050	X330231	1
63	6,9 gRB 00 D08L 063	Y330232	1
80	6,9 gRB 00 D08L 080	Z330233	1
100	6,9 gRB 00 D08L 100	A330234	1
125	6,9 gRB 00 D08L 125	B330235	0.9
160	6,9 gRB 00 D08L 160	C330236	0.9

**URB
DIN 80**

CURRENT RATING	CATALOG NO.	REF #	I/IN FUSE-BASE
16	6,9 URB 00 D08L 016	V330275	1
20	6,9 URB 00 D08L 020	T330274	1
25	6,9 URB 00 D08L 025	M330268	1
32	6,9 URB 00 D08L 032	N330269	1
40	6,9 URB 00 D08L 040	P330270	1
50	6,9 URB 00 D08L 050	Q330271	1
63	6,9 URB 00 D08L 063	R330272	1
80	6,9 URB 00 D08L 080	D330237	1
100	6,9 URB 00 D08L 100	E330238	1
125	6,9 URB 00 D08L 125	F330239	0.9
160	6,9 URB 00 D08L 160	G330240	0.85
200	6,9 URB 00 D08L 200	H330241	0.85
250	6,9 URB 00 D08L 250	J330242	0.80
315	6,9 URB 00 D08L 315	K330243	0.75
350	6,9 URB 00 D08L 350	L330244	0.75
400	6,9 URB 00 D08L 400	M330245	0.70
450	6 URB 00 D08L 450	N330246	0.65

**GERMAN STANDARD ACCORDING TO DIN 43653/00C
DIN 80 & 110**

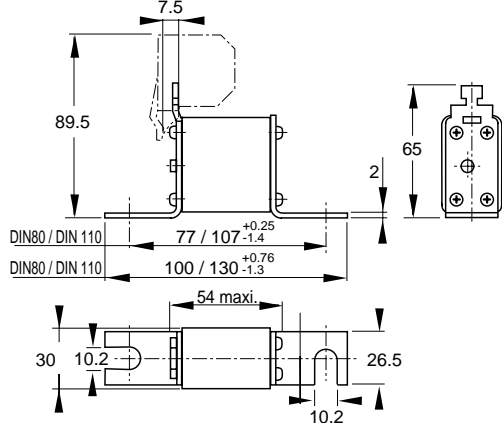

**gRB
DIN 110**

16	6,9 gRB 00 D11L 016	W330276	1
20	6,9 gRB 00 D11L 020	P330247	1
25	6,9 gRB 00 D11L 025	Q330248	1
32	6,9 gRB 00 D11L 032	R330249	1
40	6,9 gRB 00 D11L 040	S330250	1
50	6,9 gRB 00 D11L 050	T330251	1
63	6,9 gRB 00 D11L 063	V330252	1
80	6,9 gRB 00 D11L 080	W330253	1
100	6,9 gRB 00 D11L 100	X330254	1
125	6,9 gRB 00 D11L 125	Y330255	0.9
160	6,9 gRB 00 D11L 160	Z330256	0.9

**URB
DIN 110**

80	6,9 URB 00 D11L 80	A330257	1
100	6,9 URB 00 D11L 100	B330258	1
125	6,9 URB 00 D11L 125	C330259	0.9
160	6,9 URB 00 D11L 160	D330260	0.85
200	6,9 URB 00 D11L 200	E330261	0.85
250	6,9 URB 00 D11L 250	F330262	0.80
315	6,9 URB 00 D11L 315	G330263	0.75
350	6,9 URB 00 D11L 350	H330264	0.75
400	6,9 URB 00 D11L 400	J330265	0.70
450	6 URB 00 D11L 450	K330266	0.65

Weight : 140 g(D08) - 190 g(D11)

Packaging : 3 pieces

Microswitches: 6.3 clips | MS 4L 2.5 B6 - Part #: L076646
or MC 4L 2.5 B6 + PRES - Part #: F210156
2.8 clips | MS 4L 2.5 B2 - Part #: G076642
or MC 4L 2.5 B2 + PRES - Part #: G210157

Fuse-base: SI 00 DIN 80 - Part #: Q098040

GERMAN STANDARD ACCORDING TO DIN 43620/00

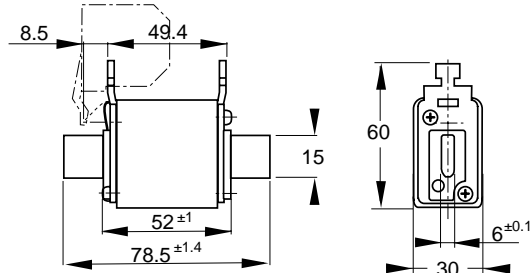

**gRB
DIN 43620**

CURRENT RATING	CATALOG NO.	REF #	I/IN FUSE-BASE
16	6,9 gRB 00 PV/016	L330267	1
20	6,9 gRB 00 PV/020	W330207	1
25	6,9 gRB 00 PV/025	X330208	1
32	6,9 gRB 00 PV/032	Y330209	1
40	6,9 gRB 00 PV/040	Z330210	1
50	6,9 gRB 00 PV/050	A330211	1
63	6,9 gRB 00 PV/063	B330212	0.90
80	6,9 gRB 00 PV/080	C330213	0.90
100	6,9 gRB 00 PV/100	D330214	0.90
125	6,9 gRB 00 PV/125	E330215	0.85
160	6,9 gRB 00 PV/160	F330216	0.85

**URB
DIN 43620**

80	6,9 URB 00 PV0080	Z320159	0.90
100	6,9 URB 00 PV0100	D320163	0.90
125	6,9 URB 00 PV0125	F320165	0.85
160	6,9 URB 00 PV0160	K320169	0.85
200	6,9 URB 00 PV0200	M320171	0.85
250	6,9 URB 00 PV0250	R320175	0.80
315	6,9 URB 00 PV0315	W320179	0.75

Weight : 210 g

Packaging : 3 pieces

Microswitches: 6.3 clips | or MC 4L 2.5 B6 + PRES - Part #: F210156
2.8 clips | or MC 4L 2.5 B2 + PRES - Part #: G210157

Fuse-base: 41002-G

I/IN : Ratio RMS steady current / current rating for fuses in base.

ELECTRICAL CHARACTERISTICS

Total Clearing I^2t - gRB

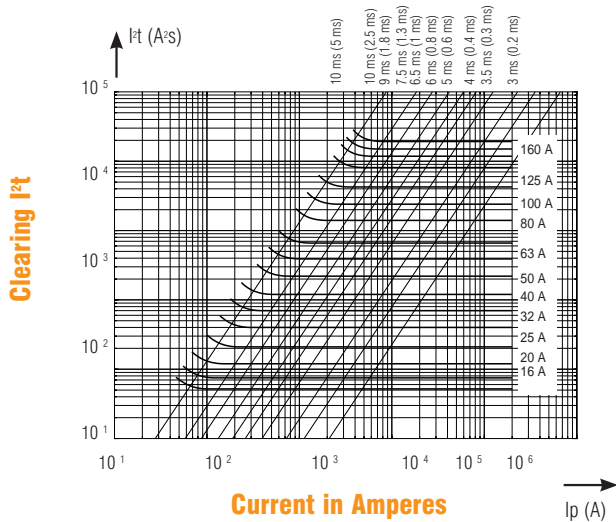

Total Clearing I^2t - URB

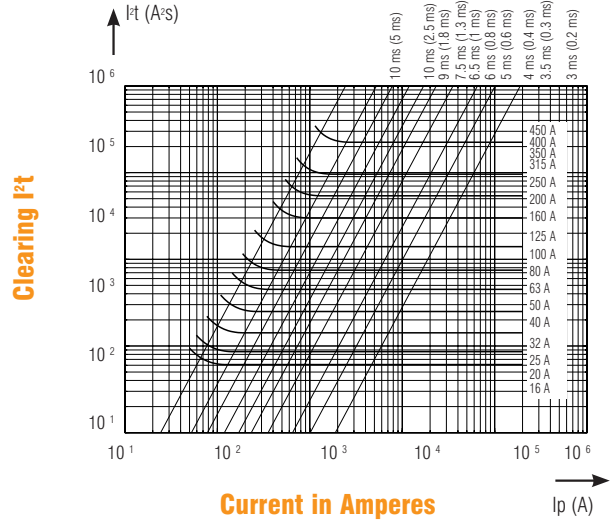

The flat curves show for each rated current the maximum values of total clearing I^2t (I^2t_1) as a function of a prospective current I_p . @ U_N with $\cos \phi = 0.15$.
The crosswise lines indicate the total clearing duration T_t and the associated pre-arcing duration in brackets.

I^2t Correction Factor

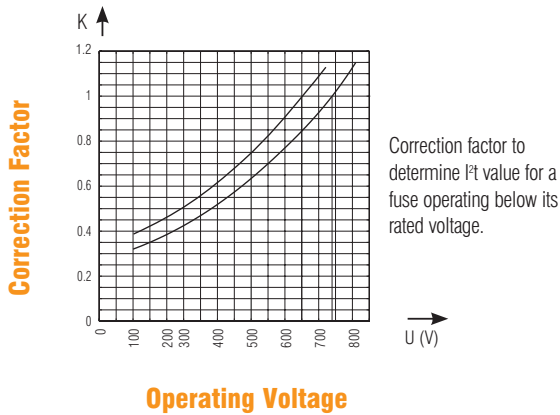

Peak Arc Voltage

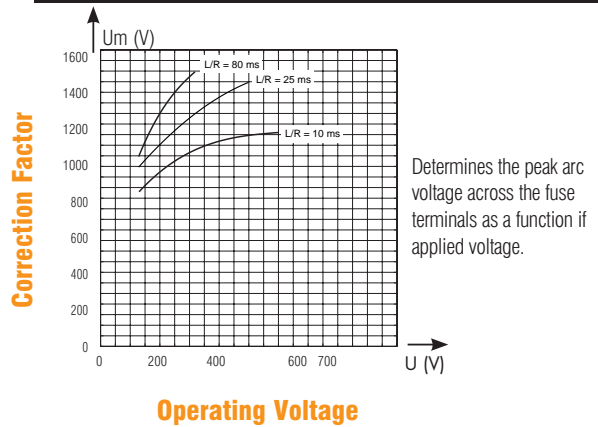

Watt Loss Correction

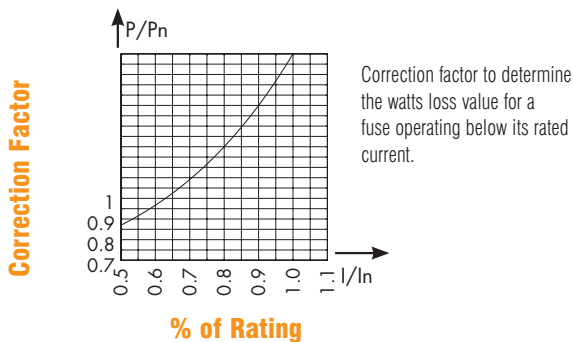

D.C. Voltage capability vs. Time Constant

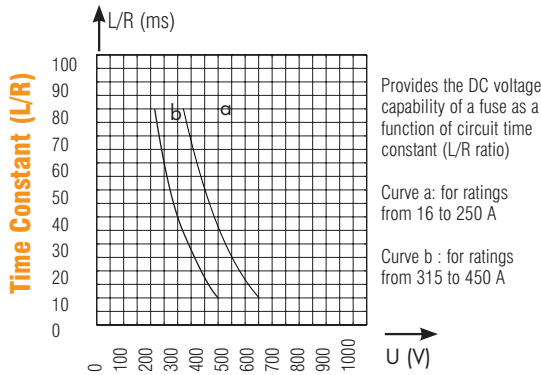

Rated Current	Curve	I _{pm} (A)	gRB	URB
16	a	32	32	
20	a	40	40	
25	a	50	50	
32	a	64	64	
40	a	80	80	
50	a	100	100	
63	a	126	126	
80	a	160	170	
100	a	200	220	
125	a	250	280	
160	a	320	390	
200	a		510	
250	a		650	
315	b		840	
350	b		1770	
400	b		2040	
450	b		2250	

The I_{pm} values give the minimum DC interrupting current in amps.

DC Peak Arc Voltage

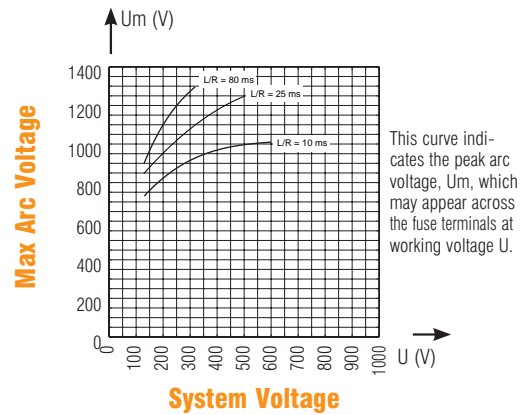

DC Voltage Capability

Peak Let-Thru Data - gRB

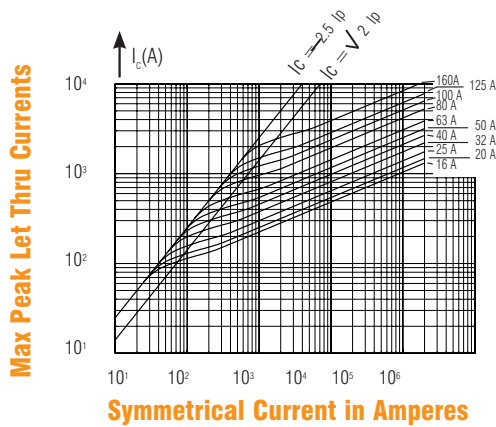

Peak Let-Thru Data - URB

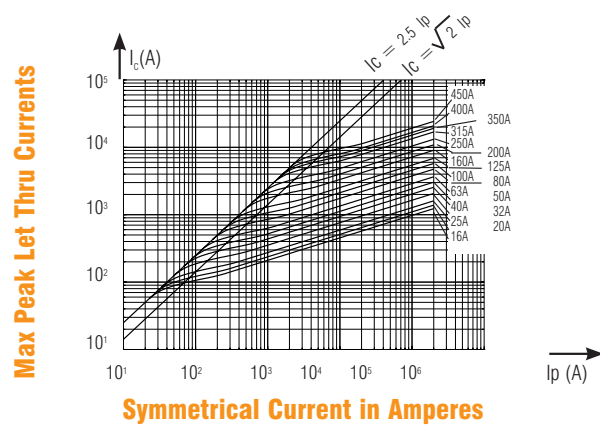

Melting Time - Current Data - gRB

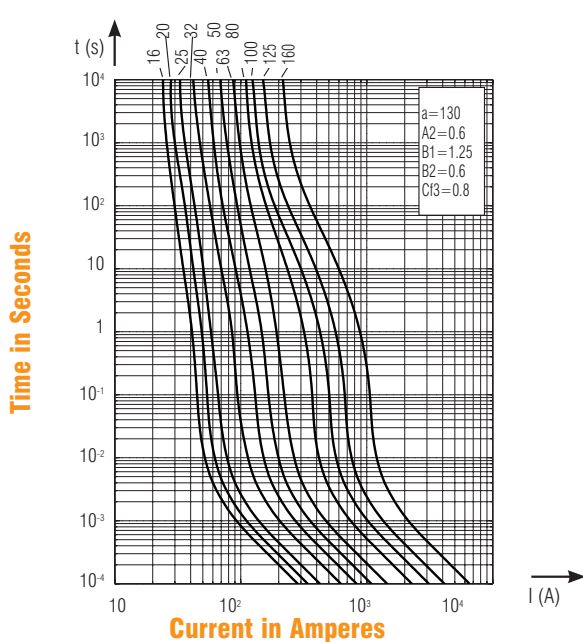

Melting Time - Current Data - URB

